

- Microcontroller design
- Independent adjustments (Incl. ramp up and ramp down)
- 3 digit extra bright seven segment LED display
- Large, easy-to-use adjustments and readout
- Display and adjust actual values (current & voltage)
- Wide range of supply voltage
- User selectable input type through menu setup (ex: 0 to 5V, 0 to 10 V, 4 to 20 mA)
- Wide ramp time range (0 to 99,5 sec)
- Simple control with analog input, locally supplied reference voltage
- Energy efficient PWM circuit, no heat sink required
- Electronic limiting circuit/ short circuit proof
- Reverse polarity, command input protection
- Load can be connected and disconnected live



Functional Description

The control electronics is intended for controlling of proportional valves with one control solenoid. Its great advantage is a miniature design in form of a socket for a standardized DIN connector base. On the electronic card's top surface, two revolving selectors, a terminal block for connecting of supply and control wires, and three-position LED display are attached. The selector marked as "SELECT" serves for selecting of parameters

for setting up. The second selector, marked as "ADJUST", serves for setting up of a desired value. In a basic mode, the display shows an input/output parameter value; conversely, in a setting mode, a selected parameter abbreviation and the value being set up are indicated. Setting up of an input control signal selected type .

Technical Data

Operating Voltage	V DC	9 - 36		
Maximum output current	A	3,00		
Input signal		0 - 5 [V]	0 - 10 [V]	4 - 20 [mA]
Maximum ramp time	s	99,5		
PWM / Dither frequency	Hz	40 - 450		
Linearity	%	1		
Operating Temperature	°C	- 40 ... 75		
Recommended cross-section of lead-in wires	mm ²	0,5 ... 0,75		
Protection Grade		IP 65		

Attention:

A cable with a circular cross-section and outside diameter of 4 to 6mm should be used for the electronics supply, only this way the declared degree of IP protection can be secured.

Schematics

1) EXTERNAL INPUT SIGNAL CONNECTION

("in" set to "10")

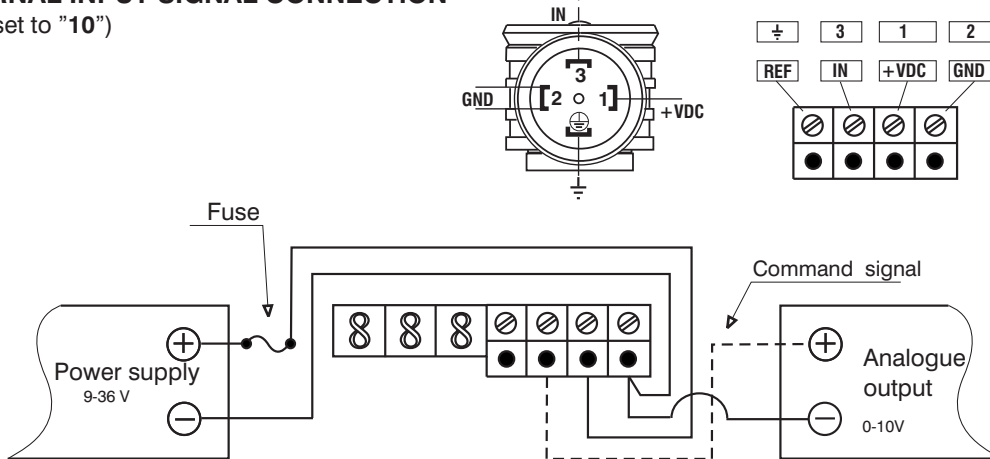

2) POTENTIOMETER CONNECTION

("in" set to "5")

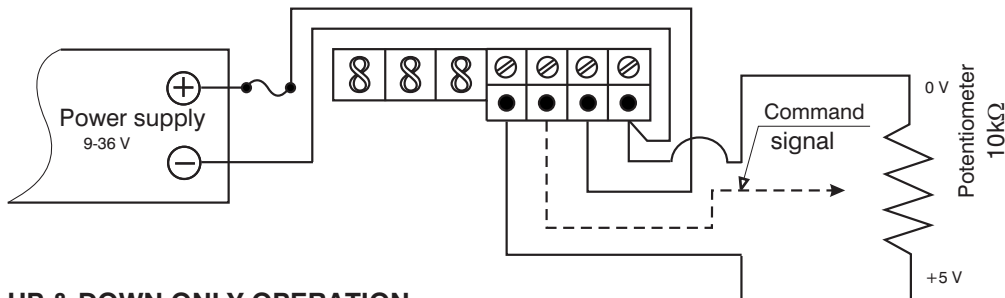

3) RAMP UP & DOWN ONLY OPERATION

("in" set to "5")

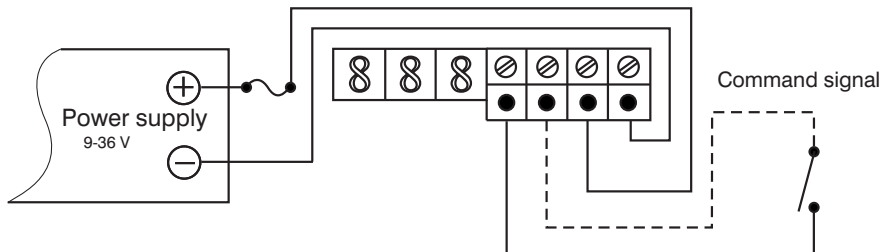

4) EXTERNAL INPUT SIGNAL CONNECTION 4-20 mA

("in" set to "420")

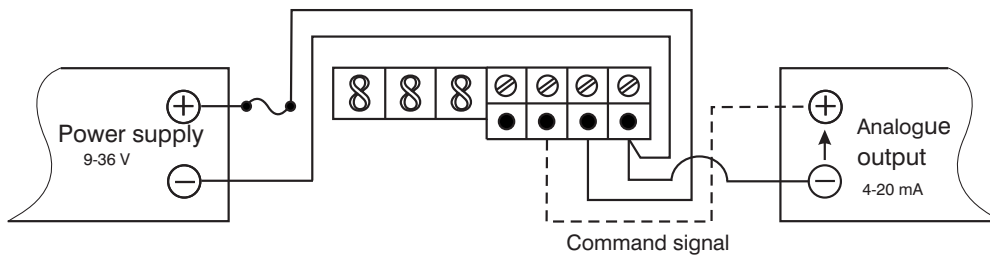

4) TWO WIRE TRANSMITTER INPUT CONNECTION 4-20 mA

("in" set to "420")

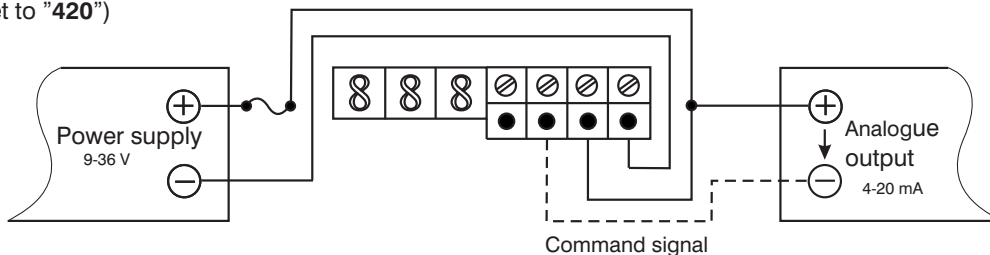

Set-up Procedure

Attention:

- Prior to setting up parameters, you must select proper Input Signal setting for your system.
Voltage signal from 0 to 10 V is standardly preset.
 - Applying improper Input Signal to wrong setting on the Driver may be damaging to Driver Unit and may cause driver to fault to „Error“ Status mode .
1. At power up, the display will show either the output current signal or the input signal (Default display setting shows the output signal). The decimal point will be flashing.
 2. Rotate „SELECT“ to enter the set-up mode. Parameter abbreviation is indicated on the display
 3. When you reach the setting you want to modify, rotate „ADJUST“ up or down to the desired value.
 4. To modify another setting, rotate „SELECT“ again and repeat..
 5. The Driver is fully functional during the set-up procedure with any adjustments effective immediately.
 6. In order to write the new settings in the memory and return to normal mode of operation, rotate „SELECT“ until the display shows „SR“ and then rotate „ADJUST“ from 0 to 1 or wait for 100 seconds.
 7. If you do not want to save the new settings you have just modified, you must disconnect the Driver from the power supply before the end of the 100 seconds to restore precious settings.
 8. After saving parameters to memory, the decimal point will be flashing and the Driver display will be back showing either the output current signal or input signal depending on your „di“ selection.
 9. To start over completely, you can restore the factory settings by rotating „SELECT“ to „rFP“ and then rotate „ADJUST“ up from 0 to 10 for the display to reset. (NOTE for Step 9: You may have to adjust your Input Signal Setting again if you reset to factory settings.)

Table settings

Parameter Abbreviation	Parameter	Adjustable Range
Hi	HIGH, Maximum Current Output	0,20 – 3,00 A
Lo	LOW, Minimum Current Output	0,00 – 2,99 A
rUP	RAMP UP, Time for Output to Increase from min to max	0,0 – 99,5 s
rdn	RAMP DOWN, Time for Output to decrease from max to min	0,0 – 99,5 s
Cdb	area of insensibility – an output current for a coil is zero, until a control signal will exceed a threshold of insensibility (the threshold is expressed in % of the control signal maximum value)	0 – 5 %
dFr	DITHER FREQUENCY, 40 (40Hz) to 450 (450Hz)	40 – 450 Hz
in 5 10 420	Input control signal type selection - Voltage signal - Voltage signal - Current signal	0 – 5 V 0 – 10 V 4 – 20 mA
di 0 1	Signal value indication for checking or problem solving purposes - Command signal [V] or[mA] - Output signal [A] Flashing decimal point is an indicator for present display mode*: - Fast Flashing decimal point, several flashes per second indicates – Command signal (di = 0) - Slow Flashing decimal point, 1 per second indicates) – Output signal (di = 1) - No Flashing decimal point or No decimal point indicates display in SETTING/ADJUST	
SR	SAVE SETTINGS	
rFP	RESET FACTORY PARAMETERS	
Err 0 1 2	ERROR DETECTION STATE, Short Circuit, Reverse polarity protection and detection - Error 0 - No Errors - Error 1 - Overcurrent in driver likely due to short circuit in Solenoid - Error 2 - Current exceeding 20 mA in „4 to 20mA“ input mode	
CLr	CLEAR ERROR, Clears Driver of Error State	

NOTE: When adjusting the HI and LO parameters, note the HI parameter value cannot be adjusted below the LO parameter value as well the LO parameter value cannot exceed the HI parameter value.

Range Adjustment

Adjustment of Maximum:

(High) / parameter „Hi“

Maximum Current output **0,20 až 3,00 A**

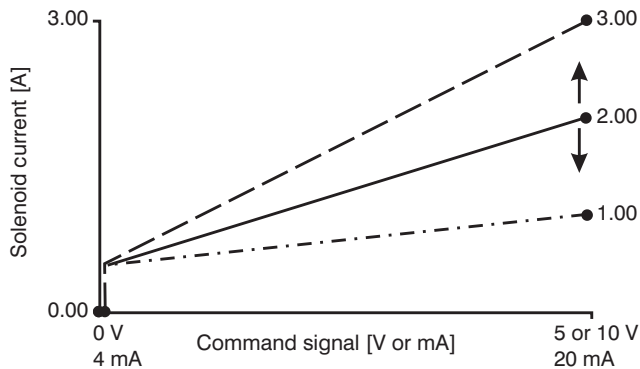

Adjustment of minimum

(Low) / parameter „Lo“

Maximum Current output **0,00 až 2,99 A**

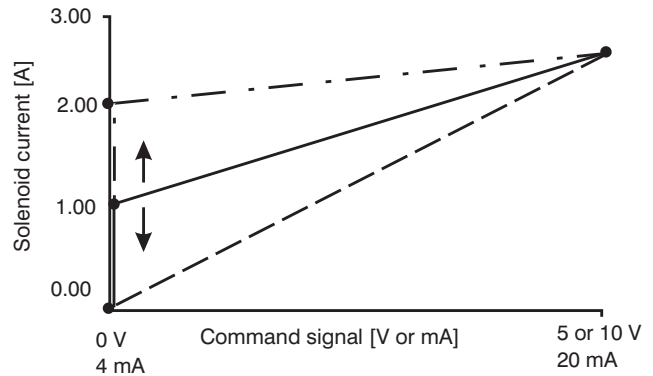

Adjustment Ramp

(Ramp up) / parameter „rUP“

Time for Output to Increase from min to max, 0 až **99,5 s**

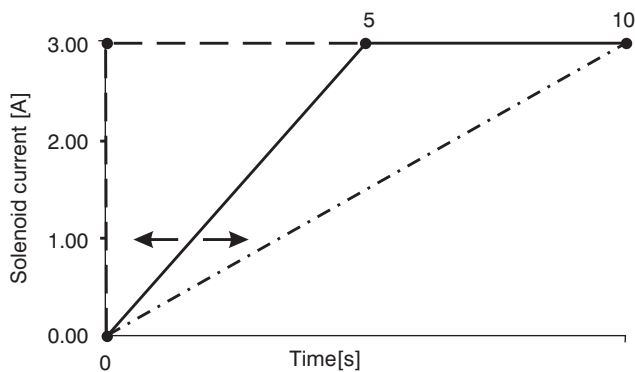

Adjustment Ramp

(Ramp down) / parameter „rdn“

Time for Output to Decrease from max to min **0 až 99,5 s**

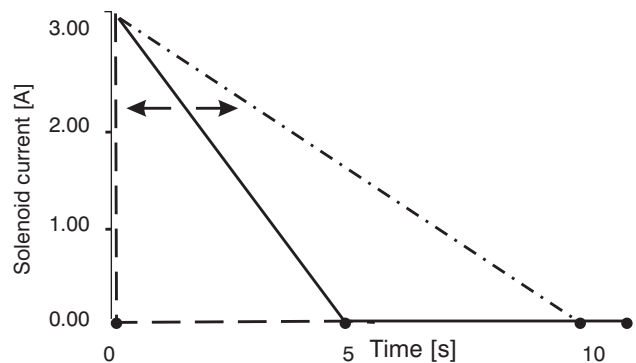

Adjustment (Command deadband) / parameter „Cdb“

Output disabled if command signal less than deadband
0 až 5 % of the maximum Command signal

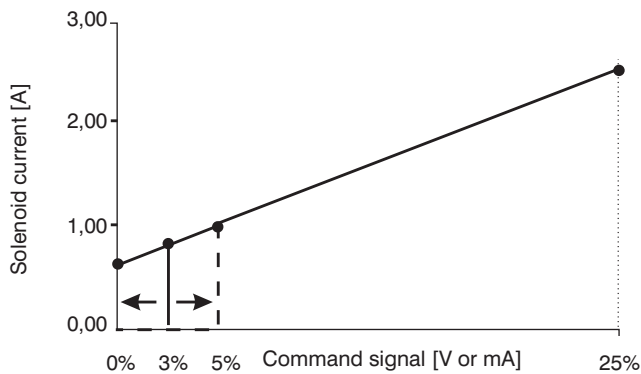

DITHER FREQUENCY / parameter „dFr“

Frequency settable in a range of **40 až 450 Hz**

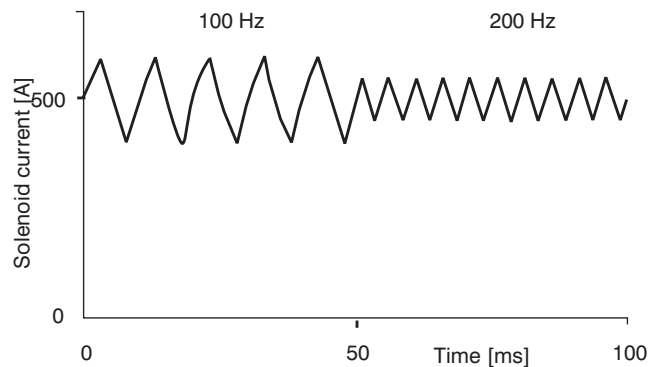

Dimensions

Dimensions in millimetres (inches)

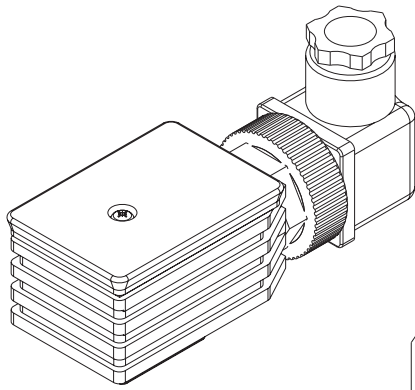

DETAIL A
M 2:1

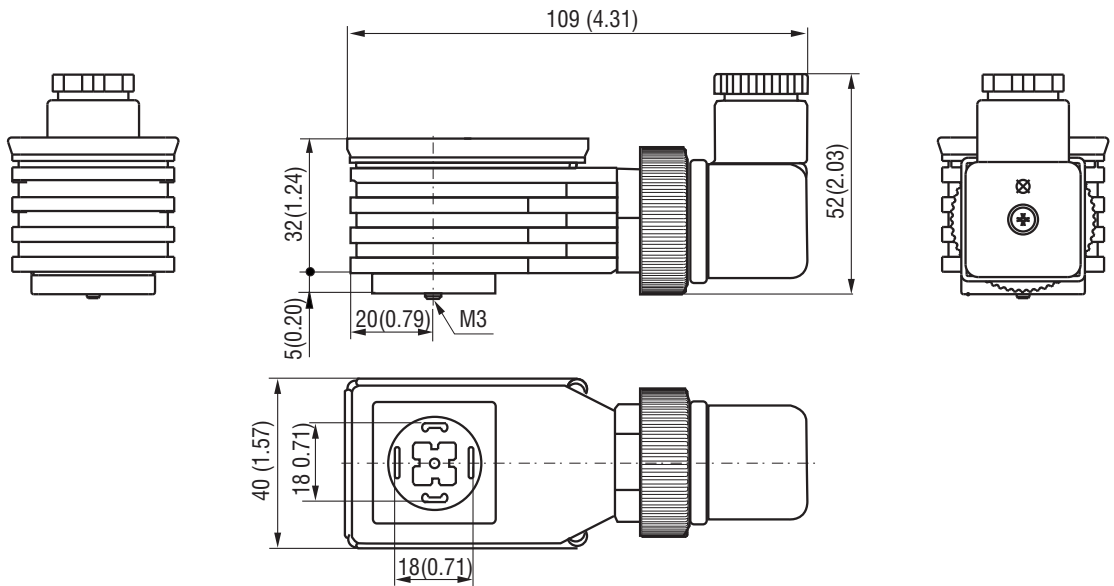
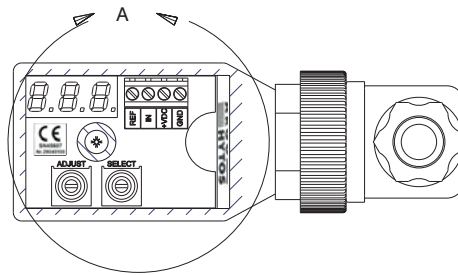
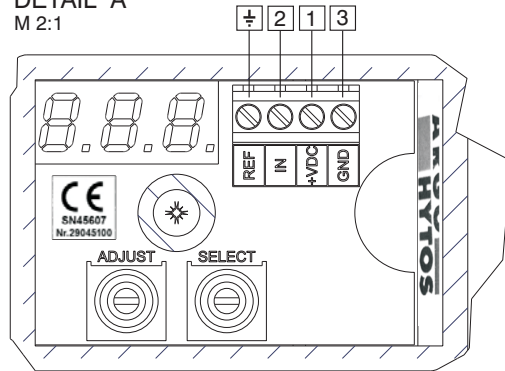

Caution!

- The packing foil is recyclable.
- The technical information regarding the product presented in this catalogue is for descriptive purposes only. It should not be construed in any case as a guaranteed representation of the product properties in the sense of the law.

ARGO-HYTOS s.r.o. CZ - 543 15 Vrchlabí
Tel.: +420-499-403 111
E-mail: info.cz@argo-hytos.com
www.argo-hytos.com